











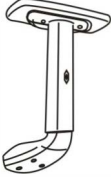











































Cascade Mesh Chair

Back Upholstery	Seat Upholstery	Armrest	Castor	Base	Gaslift	Mechanism	Screw Sets																																																
							<table border="1"> <tr> <td>S1</td> <td>X 4</td> <td></td> </tr> <tr> <td>M6</td> <td>x25</td> <td></td> </tr> <tr> <td>S2</td> <td>X 4</td> <td></td> </tr> <tr> <td>M8</td> <td>x35</td> <td></td> </tr> <tr> <td>S3</td> <td>X 2</td> <td></td> </tr> <tr> <td>M6</td> <td>x30</td> <td></td> </tr> <tr> <td>S4</td> <td>X 4</td> <td></td> </tr> <tr> <td>M6</td> <td>x35</td> <td></td> </tr> <tr> <td>S5</td> <td>X 10</td> <td></td> </tr> <tr> <td>M6</td> <td>x16x1.2</td> <td></td> </tr> <tr> <td>S6</td> <td>X 4</td> <td></td> </tr> <tr> <td>M8</td> <td>x18x2.0</td> <td></td> </tr> <tr> <td>S7</td> <td>X 1</td> <td></td> </tr> <tr> <td>M5</td> <td></td> <td></td> </tr> <tr> <td>S8</td> <td>X 1</td> <td></td> </tr> <tr> <td>M6</td> <td></td> <td></td> </tr> </table>	S1	X 4		M6	x25		S2	X 4		M8	x35		S3	X 2		M6	x30		S4	X 4		M6	x35		S5	X 10		M6	x16x1.2		S6	X 4		M8	x18x2.0		S7	X 1		M5			S8	X 1		M6		
S1	X 4																																																						
M6	x25																																																						
S2	X 4																																																						
M8	x35																																																						
S3	X 2																																																						
M6	x30																																																						
S4	X 4																																																						
M6	x35																																																						
S5	X 10																																																						
M6	x16x1.2																																																						
S6	X 4																																																						
M8	x18x2.0																																																						
S7	X 1																																																						
M5																																																							
S8	X 1																																																						
M6																																																							
		X2		X5																																																			

Step 1

Take off the plastic cap

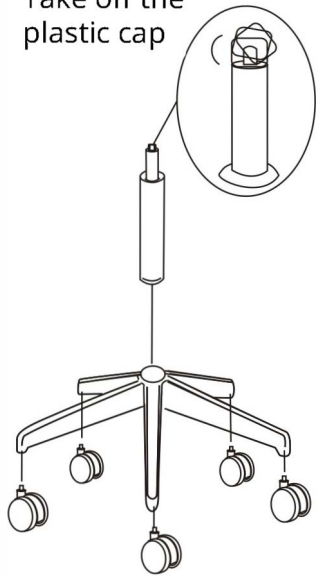

Step 2

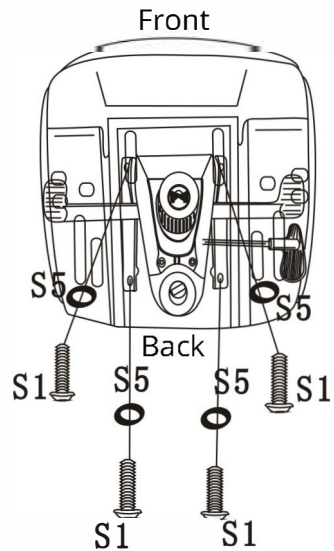

Step 3

